

8610N

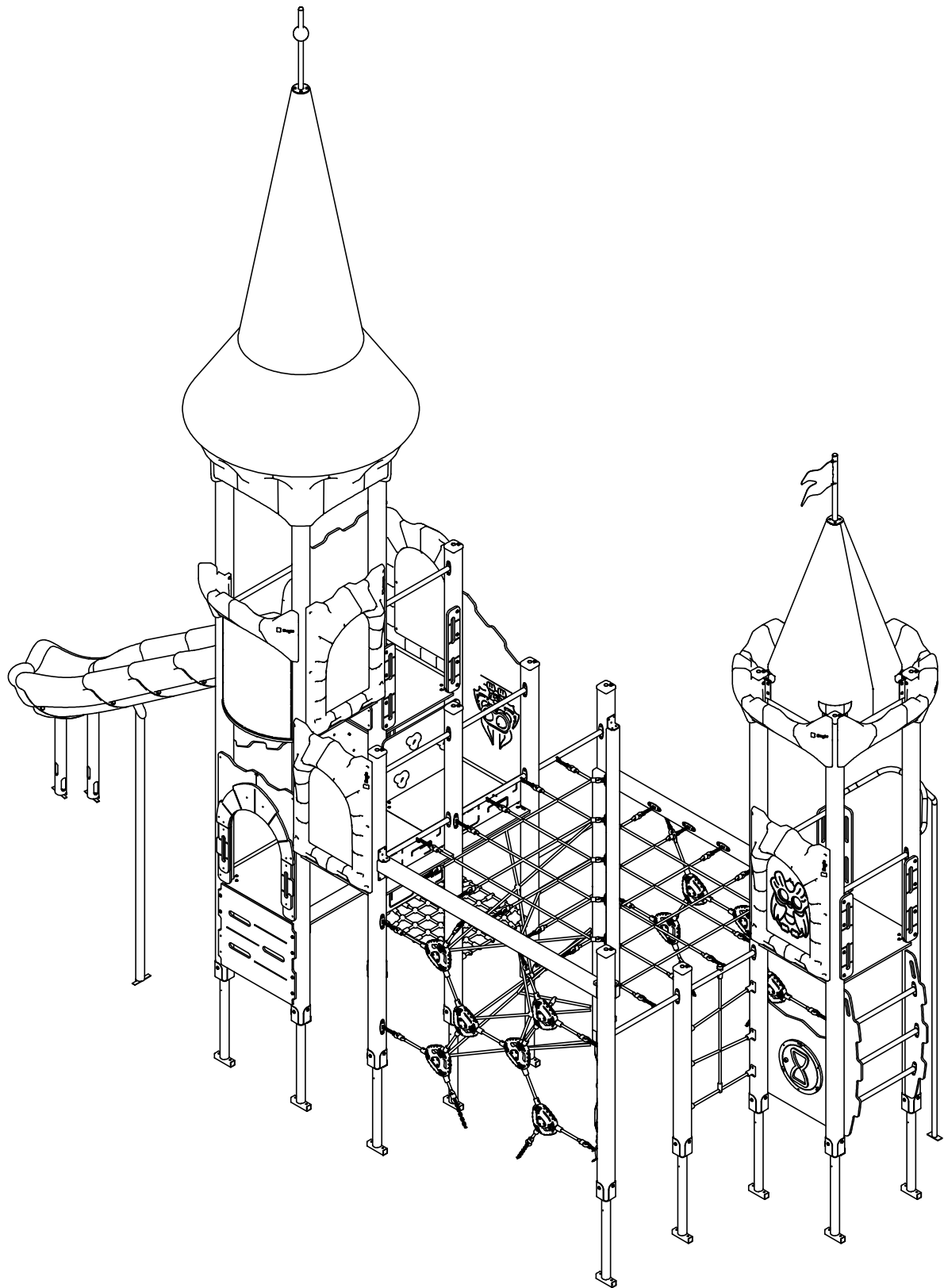

8610N

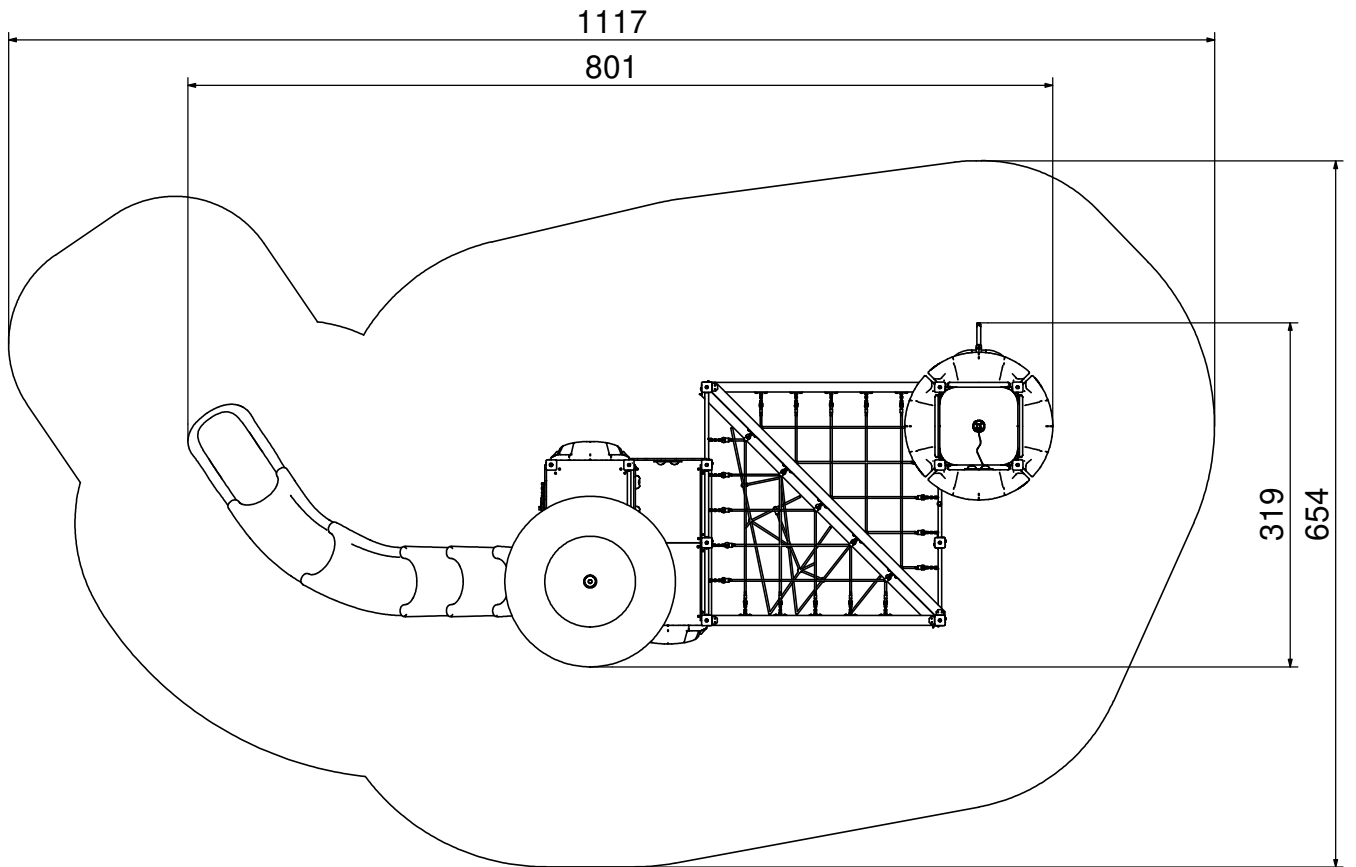
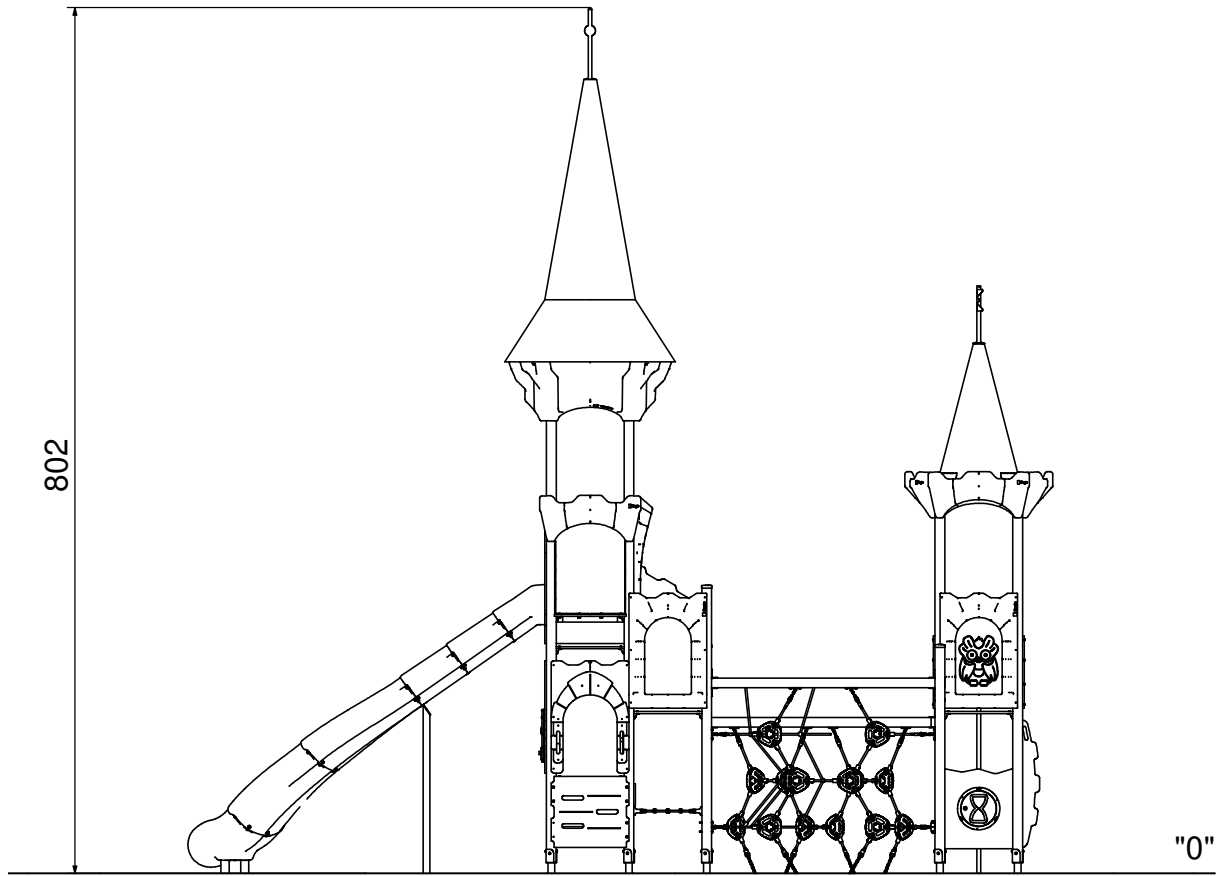

8610N

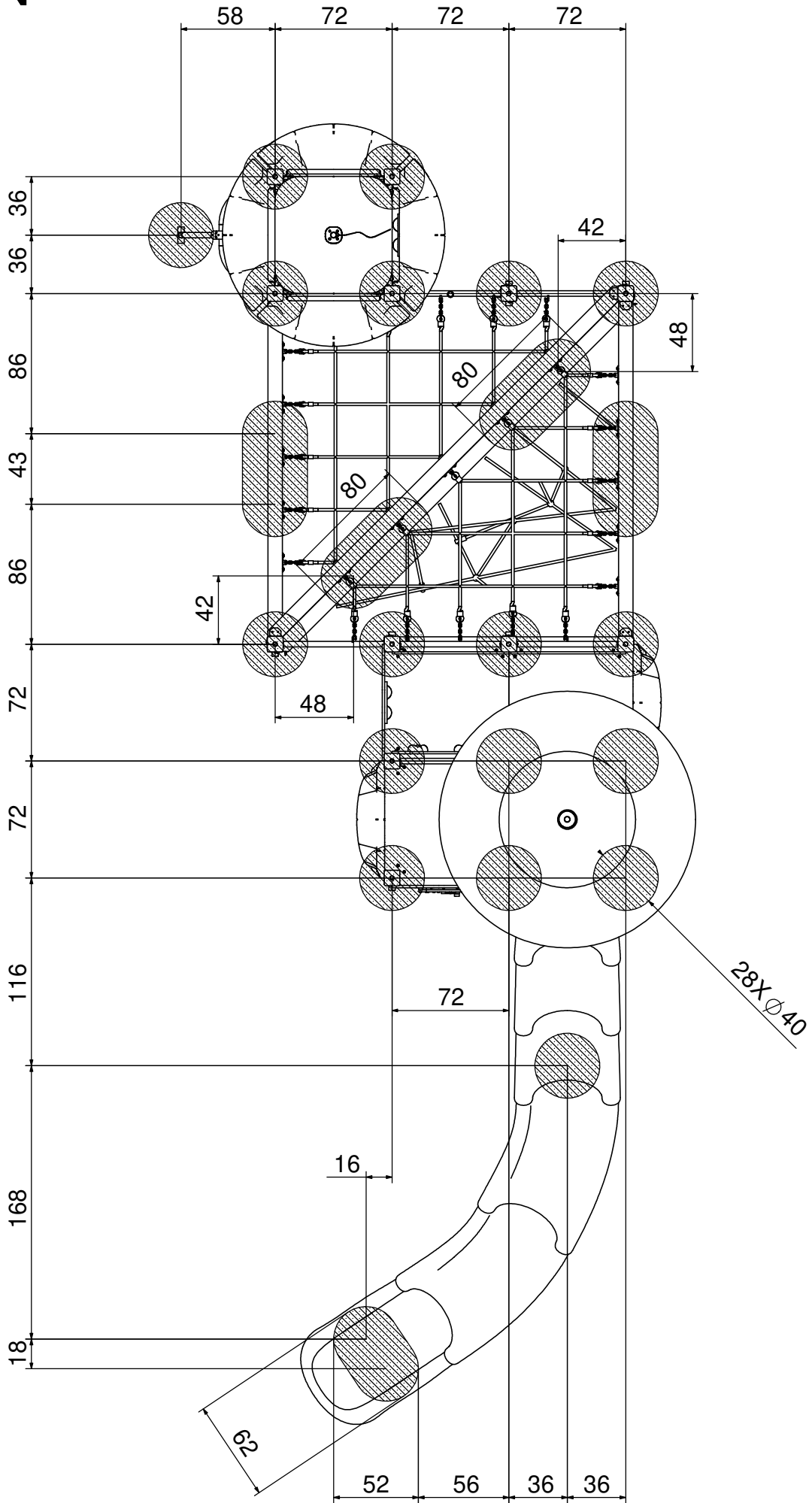

8610N

B25 0,75m³

min. 48H

